

SEGA

GENESIS



# SPACE HARRIER™

# II

INSTRUCTION MANUAL

## Loading Instructions: Starting Up:

1. Make sure the power switch is OFF.
2. Insert the Space Harrier II cartridge in the Genesis System (shown below) by following instructions in your GENESIS SYSTEM manual.
3. Turn the power switch ON. If nothing appears on-screen, make sure the cartridge is securely inserted into the console.

**IMPORTANT:** Always make sure the System is turned OFF when inserting or removing your Genesis Cartridge.

For 1 Player Only: Press Start Button on Genesis Control Pad 1.

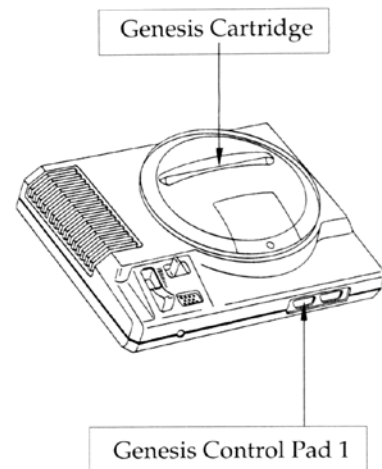

# Space Harrier™ II

The year is 6236. Space is your battlefield and destructive forces your enemy once again as Space Harrier confronts another crisis in Space Harrier II. Only this time, the call for help comes from somewhere deep in the universe, the 214th sector, which is light-years from your cruiser. However, you're armed with the "Cosmic gate," a special teleportation device, so you're there in moments. And what you see is disastrous.

Fantasyland is unrecognizable. What's clear are enemy forces, lots of them coming at you from everywhere. And there's only you and your laser. This is going to be a tough assignment at which to succeed whether your rapid fire is on or off. So follow the path to victory by staying out of the line of fire and shooting straight. It's a long and ugly road and the only ones who survive have the makings of a real hero.

Your objective is to survive twelve stages of intense combat with a horde of masterful foes. Outwit their strategy and you'll save Fantasyland from being blown to oblivion with you going along for the ride.

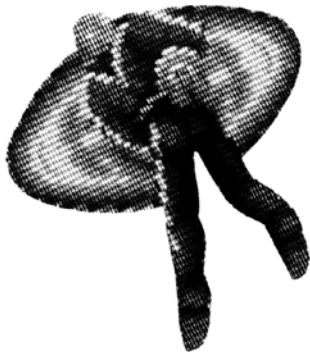

# Take Control

Before you begin playing, learn which buttons control the moves and functions you'll rely on during game play.

Directional Button  
(D-Button)



## Basic Functions of The Genesis Pad:

### Directional Button: (D-Button)

- Operates selection arrow during mode setting.
- Moves Space Harrier in eight different directions
- Selects characters for name entry
- Selects stage of play

### Start Button:

- Starts game
- Pauses screen during play
- Resumes play

### Button A:

- Fires laser
- Selects from Option Screen
- Begins play
- Selects Mode Selection screen

### Button B:

- Fires laser
- Begins play
- Operates exit during Mode Selection

### Button C:

- Fires laser
- Begins play
- Operates exit during Mode Selection

## Start Game



To begin game play, press the Start Button during the title screen and the screen will change to ALERT from FANTASYLAND. Next press either the Start Button or Button A, B, or C to advance to the next screen. Here, the name of the stage will appear on the screen. Press Button A, B, or C again and the name of the stage will begin to flash on and off. now the battle begins.

It's important to know the varying stages associated with starting the game for more options later.

## Mode Selection

Press Start Button once the title screen appears. When the title screen is on, press Button A and the Mode Selection screen will appear.

## Pause and Resume Play

During game play, should you wish to stop play momentarily, press the Start Button and the game will pause. To continue, press the Start Button again.

## Move Space Harrier In Eight Different Directions

To move Space Harrier in eight different directions, press the D-Button in the desired direction and Space Harrier will follow. Up or down, left or right, etc.

## Fire Laser

For constant firing power, press Button A, B, or C.

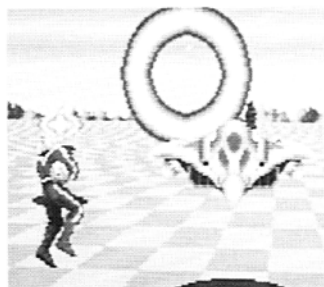

## Screen Signals and Options

Get to know the screen signals which will inform you of gains and losses. Then, see the Mode Selection Screen to increase or decrease the game difficulty.

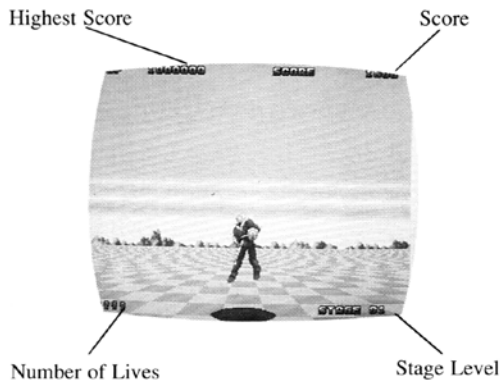

### Number Of Lives

During game play, you're given three lives for every stage. See the Option Screen to change this number. The number of lives available for play are indicated by Space Harrier illustrations in the lower left-hand corner. Every time you crash and die, you'll lose a life.

### Score

Your score is kept and updated during game play. Every time you hit a target, you'll gain points. See the upper right-hand corner.

### Highest Score

The current highest score is kept on-screen to encourage you to try harder and beat the reigning champ. See the upper left-hand corner.

### Stage Level

Your current stage is indicated in the lower right-hand corner with a number from 1 to 12.

### Game Ends

Your mission is completed when you successfully survive all twelve stages.

### Game Over

The game ends when you lose all your lives during any one stage.

## Mode Selection Screen



In order to increase your chances for winning, a Mode Selection Screen is provided to let you change standard game settings. Press the Start Button to view the title screen. Now press Button A to view the screen and use your D-Button to select among the menus. To view the menus, press Button A.

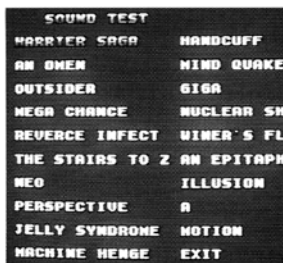

To perform a SOUND TEST, select this menu and use your D-Button to choose which of the 19 tunes you'd like to hear. Press Button A, B, or C to hear the track. To exit this menu, select "Exit" with the D-Button and press Button A, B, or C to return to the Mode Selection screen.



To change the DIFFICULTY level of the game, select this menu. Now you can change the number of lives available to Space Harrier during each stage. EASY—five lives, NORMAL—three lives, HARD—one life. To exit this screen, press Button A, B, or C to return to the Mode Selection Screen.



To change the shooting function, select the RAPID-FIRE menu. Use the D-Button to select ON or OFF. When ON, shots will be fired continuously, as long as you press a button. When OFF, a shot will be fired every time you press a button. To exit this menu, push Button A, B, or C to return to the Mode Selection Screen.

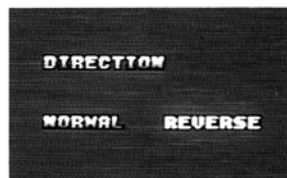

To change Space Harrier's flying DIRECTION, select this menu. Here you can reverse the up and down direction functions of the D-Button. Choose NORMAL or REVERSE with the D-Button. Depending on which is easier, NORMAL will move Space Harrier up when D-Button is pressed up, and down when pressed down. REVERSE is the opposite. To exit this screen, press Button A, B, or C to return to the Mode Selection Screen.

## Now Make Your Move

There are twelve stages to survive in Space Harrier II. Luckily, you can begin play in any given stage.

### Stage Selection

To start play from any one of the twelve stages, press the Start Button during the Title Screen. Now press either the Start Button or Button A, B, or C. The title of the first stage will appear on-screen. Press the D-Button to the left or the right to advance to a different stage.



The name of the stage will appear on-screen. To start play from the desired stage, press Button A, B, or C.

### Bonus Stage

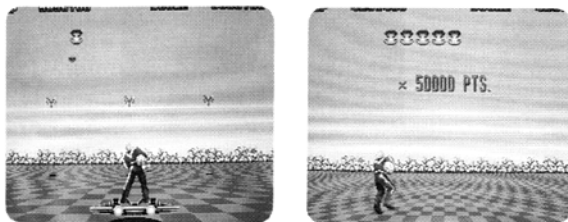

After safely surviving five stages, Space Harrier II will arrive at the Bonus Stage. Here, you'll board a flying saucer and fire away at the targets. You'll receive bonus points according to the number of targets you hit in an allotted time limit. At this time, you will not be attacked.

## Names of Stages

The twelve stage in Fantasyland are:

Stage 1: Stuna Area

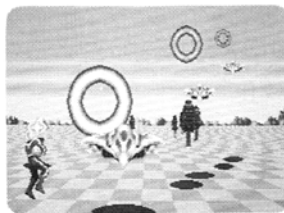

Stage 2: Fors Yard

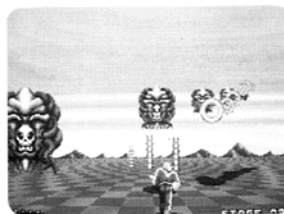

Stage 3: Yees Land

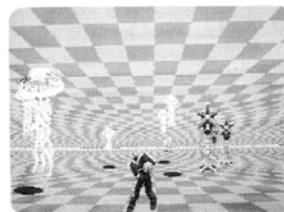

Stage 4: Zero Polis



Stage 5: Copper Hill

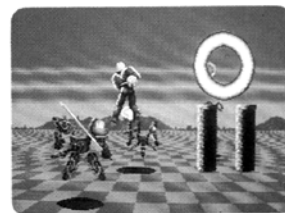

Stage 6: Fallpyram



## Stage 7: Craddha

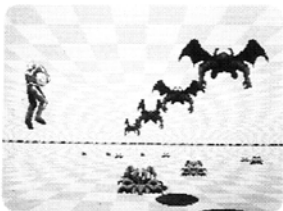

## Stage 8: Monark

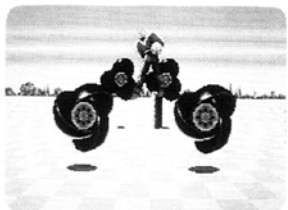

## Stage 9: Felcold

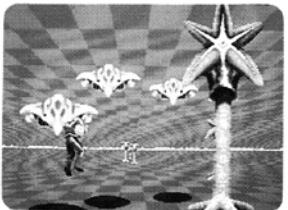

## Stage 10: Hope City

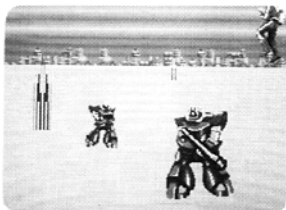

## Stage 11: Hell Peak



## Stage 12: Hot Palace

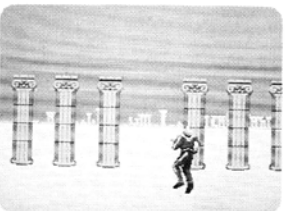

# Know The Score

## Name Entry



At the end of the game, if you've scored within the top seven scores, then you can record your initials on the Name Recording Screen which will automatically appear.

## Here's how

1. The letters of the alphabet will appear below the ranking. Move the D-Button to the left or the right to select your letter of choice. Press Button A, B, or C for the letter to appear on the ranking screen.
2. If you make a mistake when entering your initials, select the backwards arrow, then press Button A, B, or C to erase.
3. When finished, choose END, then press Button A, B, or C to return to the Title Screen.



# Space Enemies and Other Creatures

Here's a summary of your attackers physical characteristics and points value.



**Rageref:**  
20,000 points.  
Two varieties.

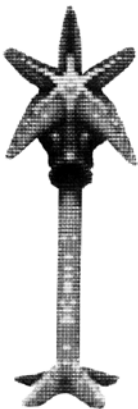

**Evil Starfish:**  
Impossible to destroy.



**Puti-Squilla:**  
50,000 points.  
Descendent from Land of Dragons.



**Land-Shel:**  
3,000 points.  
Shelled monster.

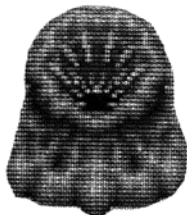

**Actinioumus:**  
3,000 points.  
Sea Anemone.



**Meca Adence:**  
20,000 points.  
Descendent from Land of Dragons.



**Pinnate Plants:**  
3,000 points.  
Burns when shot.



**Bundle-Pipe:**  
Impossible to destroy.



**Barbarian:**  
20,000 points.  
Survivor from Land of Dragons.



**Crabbom:**  
3,000 points. Crab.



**Cyborgman:**  
20,000 points.  
Will attack from behind.



**Syura:**  
20,000 points.  
Two varieties.



**Demon Toad:**  
20,000 points.  
Leaps into air and attacks.



**Ghost Armor:**  
20,000 points.  
Dead ghost warrior.



**Giddore:**  
20,000 points.  
Bat-winged creature  
that crawls.



**Obstree:**  
5,000 points.  
Burns when shot.



**Mad-totem:**  
Impossible to  
destroy.

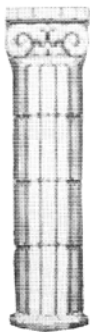

**Greek-Columnu:**  
Impossible to destroy.

## The Stage Bosses

At the end of each stage, you'll have to confront a creature more loathsome and dangerous than anything you've encountered so far. This is the Stage Boss. Here's what to look for.

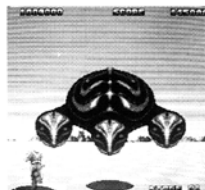

Stage 1: 200,000 points.  
Three Headed Tortoise. Shoots fireballs.



Stage 2: 200,000 points.  
Paranoiazum. Psycho balled tentacles.

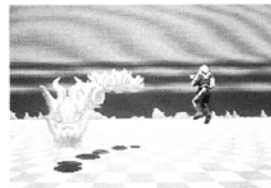
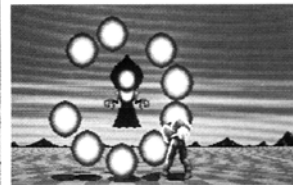

Stage 3: 200,000 points.  
Blizzard. Twisting body attack.

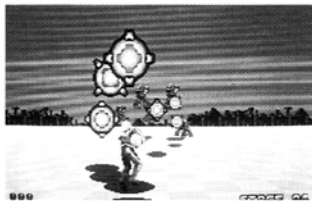

Stage 4: Neo-Dom. Group attack.  
(each) 30,000 points.



Stage 7: Medusa. Moving slowly, it changes shape.  
200,000 points.



Stage 5: Mantichora. Huge winged creature.  
200,000 points.



Stage 8: 200,000 pointseach.  
Neo Tmos. Splits its body to attack.

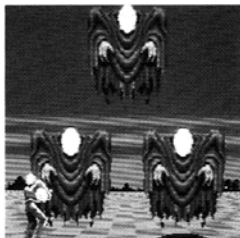

Stage 6: Wizard. Creates bodies within one body.  
200,000 points.

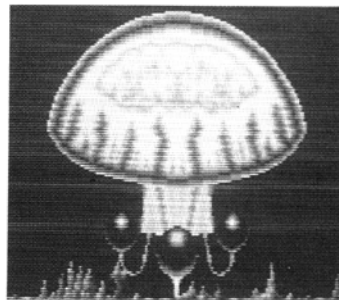

Stage 9: 100,000 points.  
Cragon. Shoots mini-cragon during attack.

## Helpful Hints

- Here's the last bit of help we can give you for your upcoming battle.
- The enemy moves very quickly. Never take your eyes off of them and be careful of the distance between you and them.
- The enemies' shots are big. When they are far away the shots look small, but when they are nearer to Harrier, they will enlarge.
- Look for weak points in Stage Bosses and shoot towards them.
- When Harrier starts running, he can't be stopped. Be careful of obstacles in your path like columns.

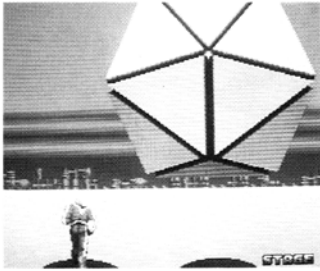

Stage 10: Binzbean. 20-sided spaceship.  
200,000 points.

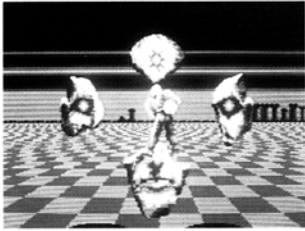

Stage 11: Rock-face. Divides into four segments.  
200,000 points.

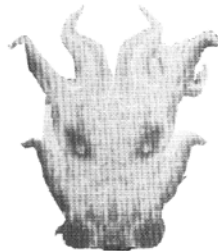
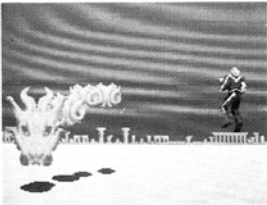

Stage 12: 200,000 points.  
Cthugha. Stronger than Blizzard.

## Scorebook

Data			
Name			
Score			

Data			
Name			
Score			

Data			
Name			
Score			

Data			
Name			
Score			

Data			
Name			
Score			

## Handling The Sega Genesis Cartridge

- The Sega Genesis Cartridge is intended exclusively for the Sega Genesis System™.
- Do not bend, crush or submerge in liquids.
- Do not leave in direct sunlight or near a radiator or other source of heat.

