

# Instruction Manual

# BIONIC COMMANDO™

[freegamemanuals.com](http://freegamemanuals.com)

CAPCOM®

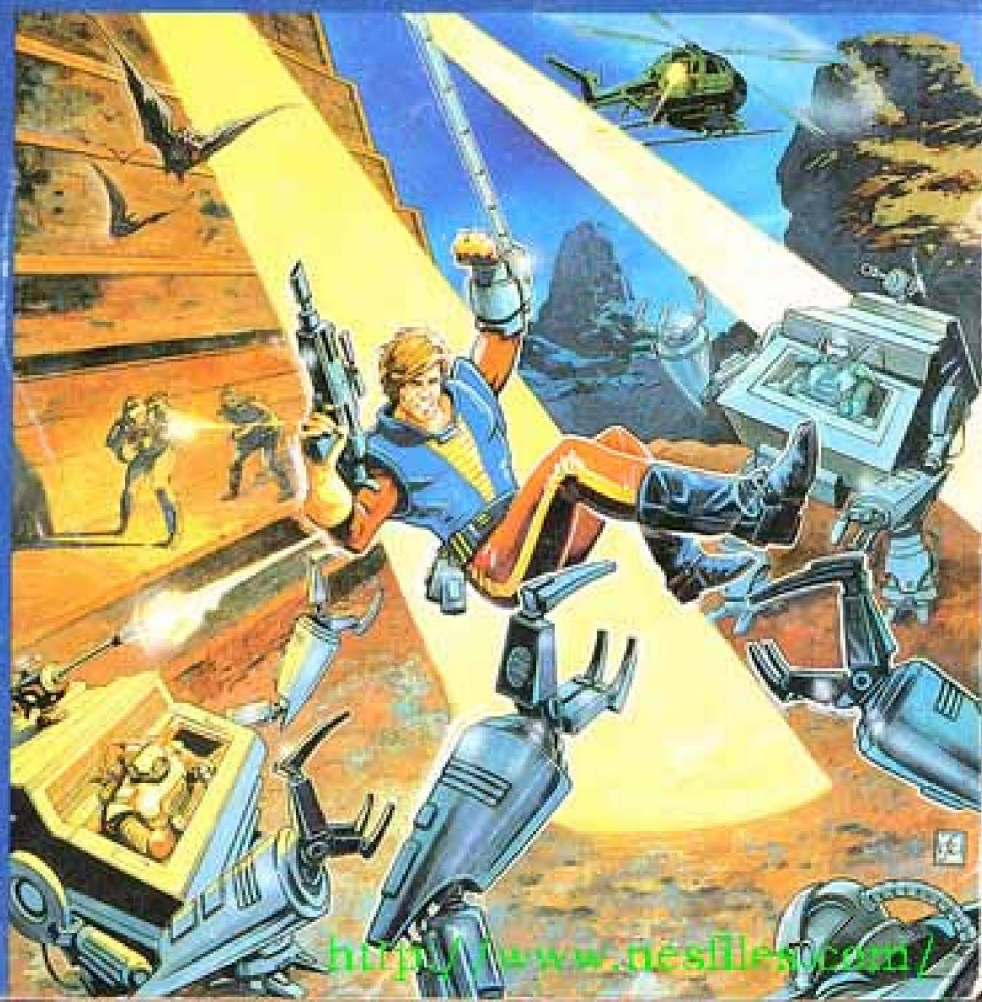

# TABLE OF CONTENTS

Special Message . . . . .	2
Safety Precautions . . . . .	3
Bionic Commando Story . . . . .	4
How to Play . . . . .	5
Earned Weapons . . . . .	13
Bonus Characters . . . . .	15
Enemy Characters . . . . .	17
Hints/Scoring/Memo . . . . .	21
Compliance with FCC Regulations . . . . .	22
90-Day Limited Warranty . . . . .	23

# A Special Message From Captain Commando!

Thank you for selecting fun-filled **Bionic Commando™** . . . one of the exclusive Nintendo Entertainment System video games from the **Captain Commando "Challenge Series"**.

**Bionic Commando™**, created by CAPCOM©...premier world-wide arcade game designer . . . features colorful state-of-the-art high resolution graphics.

This high quality game pak is

Licensed by Nintendo®  
for Play on the



CAPCOM and Captain Commando are registered trademarks of CAPCOM U.S.A., INC.  
Nintendo and Nintendo Entertainment System are trademarks of Nintendo of America Inc.

## **SAFETY PRECAUTIONS**

Please take time to read the important instructions in this booklet. Observing the step-by-step instructions and complying with the warnings will be your personal guarantee to greater game satisfaction over a long period of time.

### **SAFETY PRECAUTIONS**

- 1. Avoid subjecting this high precision GAME PAK to extreme temperature variances. Store at room temperature.**
- 2. Do avoid touching terminal connectors. Keep clean by inserting GAME PAK in protective storage case.**
- 3. Never attempt to disassemble your GAME PAK.**
- 4. Use of thinners, solvents, benzene, alcohol and other strong cleaning agents can damage the GAME PAK.**
- 5. For best results, play the game a distance away from your television set.**
- 6. Pause for 10-20 minutes after 2 hours or more of continuous game playing. This will extend the performance of your GAME PAK.**

## BIONIC COMMANDO STORY

I'll talk about a person which I've met when I was young.

In 198X we've found Nazz's top secret material called Abatros, a plan which never was put to practice.

Imperial forces Generalissimo Kilt had never seen this plan, and decided to materialize this plan.

The federation decided to stop his attempt by sending our hero Super Joe, but lost contact with him.

Our brave man (you the player) was sent to the empire with a special mission to rescue Super Joe, this story begins from here...



# HOW TO PLAY

## NAMES OF CONTROLLER PARTS & OPERATING INSTRUCTIONS

**Controller #1** — Moves Player 1.

**Button A:** Shoots Guns.

**Button B:** To extend Bionic Arm.

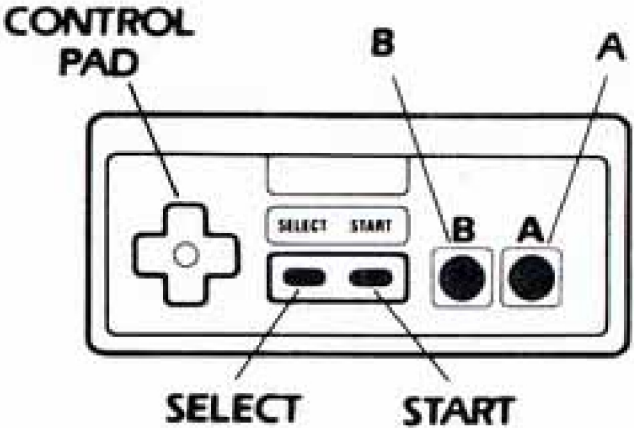

### Control Pad:

Each tip is imprinted with letter to show direction or movement:

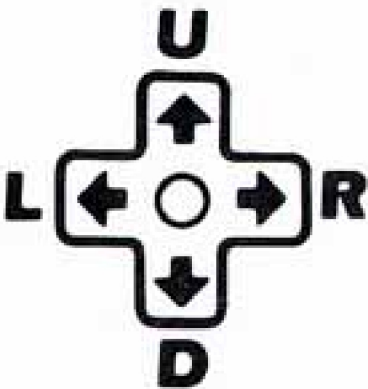

### Four Separate Action Tips

Pressing any of four tips moves you and player moves that direction.

- ◀ Player moves left.
- ▶ Player moves right.
- ▲ Player moves upward.
- ▼ Player moves down.

## HOW TO PLAY

1. Normal Gun, Wide Gun, Rocket Gun, 3-Way Gun, Machine Gun, Hyper Bazooka are used by Button B.
2. Flare Bomb, Medicine are used by Start Button.
3. Items like 1 Up, POW, Medicine which come down on parachutes can be used by catching them.

# HOW TO PLAY

Stage Map  
(Area 0 thru 19)

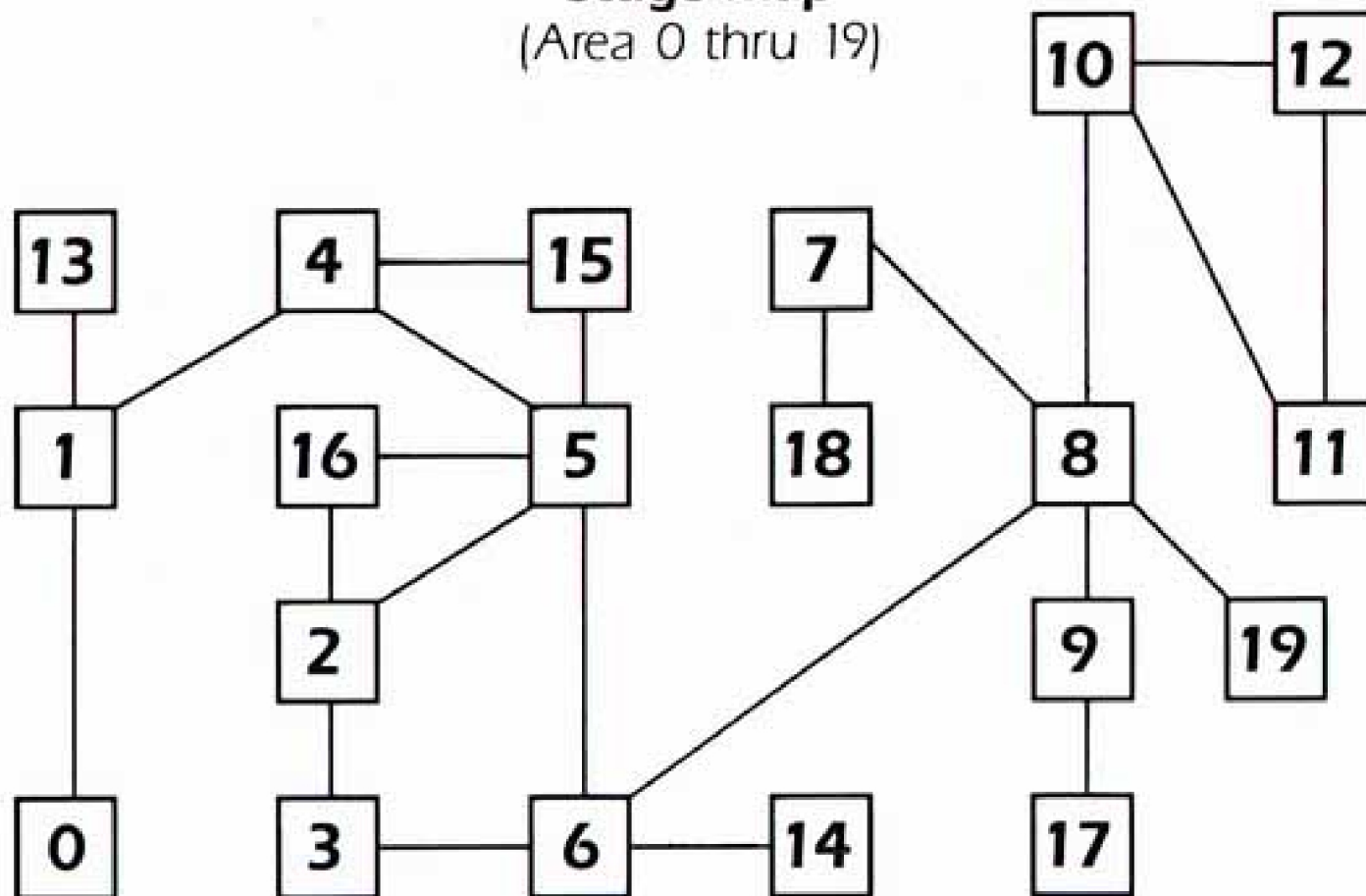

Area.



# HOW TO PLAY

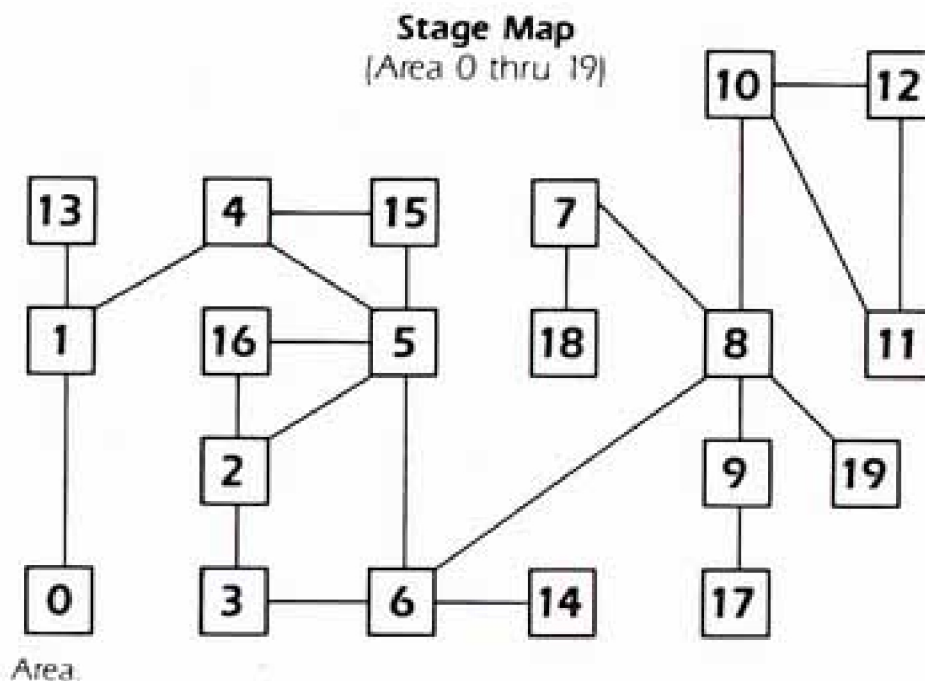

Use map in subscreen to proceed with your game.

Player starts from area 0 and transfer along the route.

Each numbered squares are the areas and as soon as your player reaches, screen will change to battle scene.

Helicopter will transfer your player to the destination area.

# HOW TO PLAY

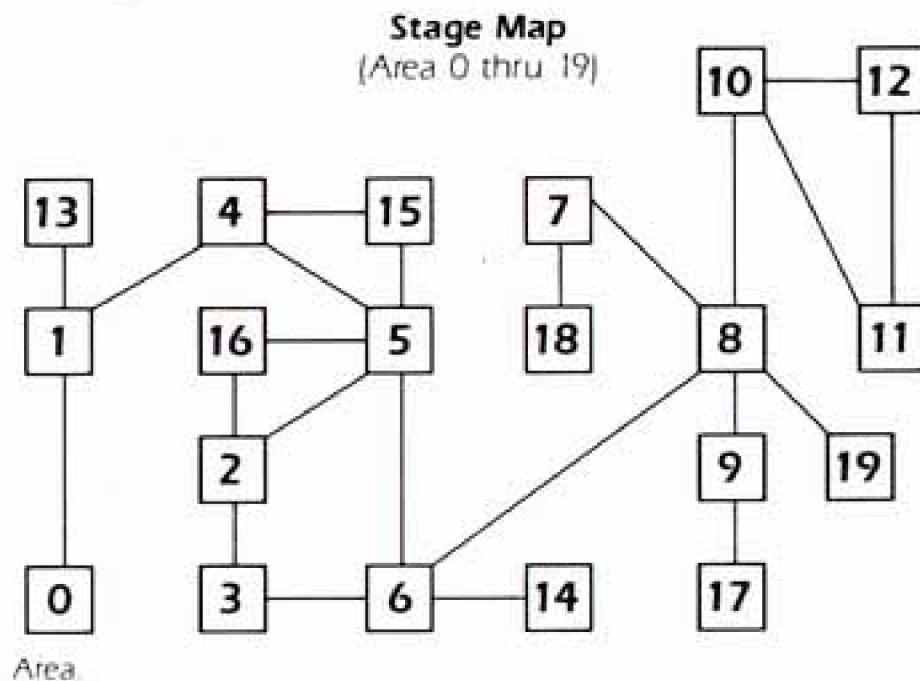

When your player helicopter starts to transfer, enemy vehicles will start to move also.

When you reach destination without being confronted by enemy vehicle, you have a choice of either to play that area (descend) or still transfer to other area.

# WEAPON SELECTION

## MENU

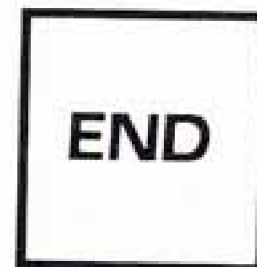
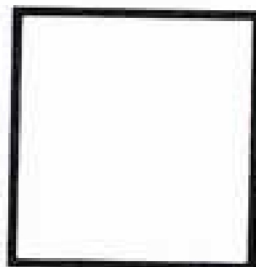
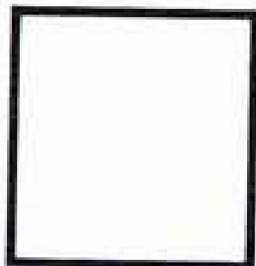
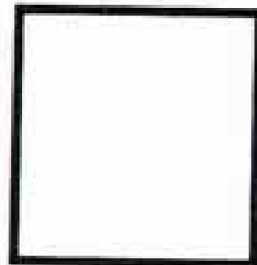
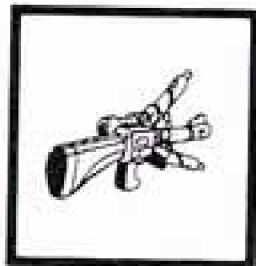

# HOW TO PLAY

## WEAPON SELECTION

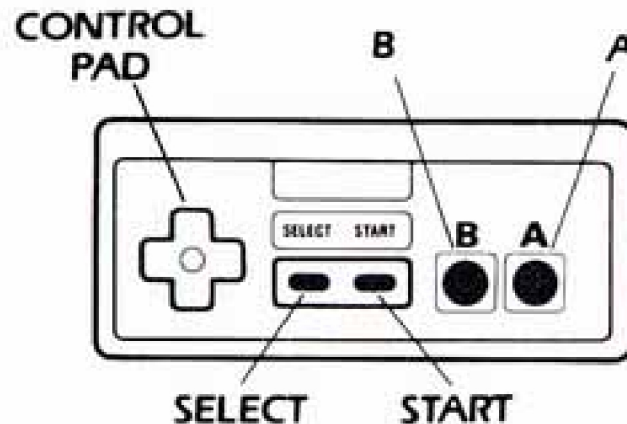

Item selection can be done using your controller cursor.

Move flashing squares to item you want, then press "A" twice to start, you can cancel it.

# HOW TO PLAY

MENU

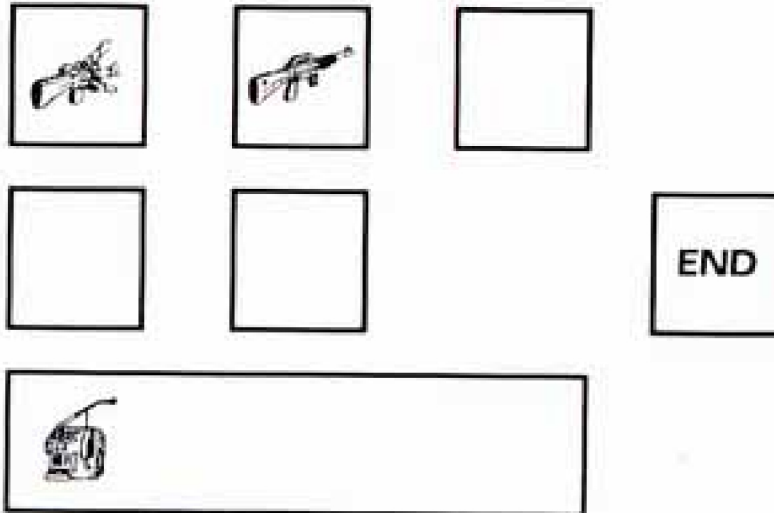

When player decides to "descend", weapons selection scene will appear.

You may take weapon, protector, special weapon, and communicators and you may select one each.

You can obtain more items while you play and stock them as you go and you'll have more to choose from.

## EARNED WEAPONS

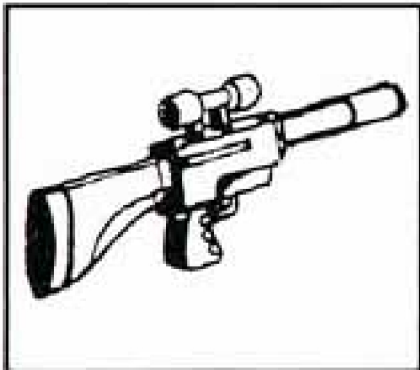

### Normal Gun

You have it to start with

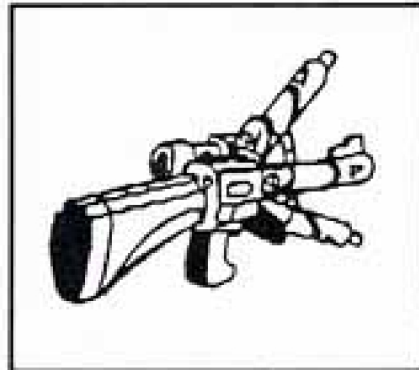

### Wide Gun

You can shoot at wide range but reach is short

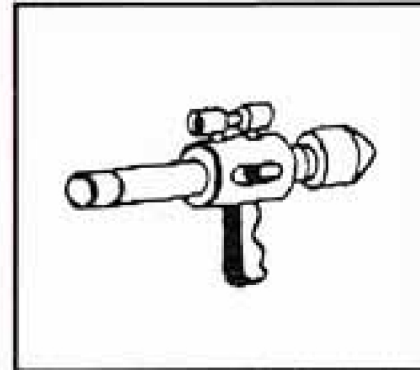

### Rocket Gun

It penetrates and destroys enemies, you can shoot continuously

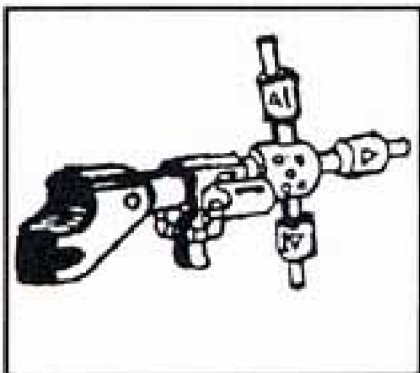

### 3-Way Gun

You can shoot in 3 ways  
It can break the shield

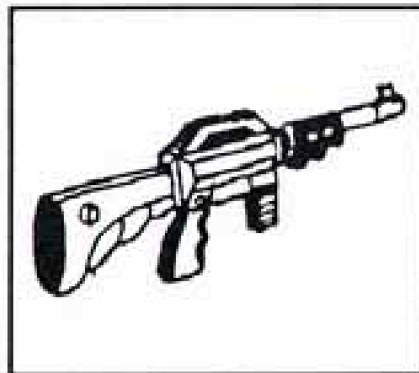

### Joe's Machinegun

Range — 22.5°

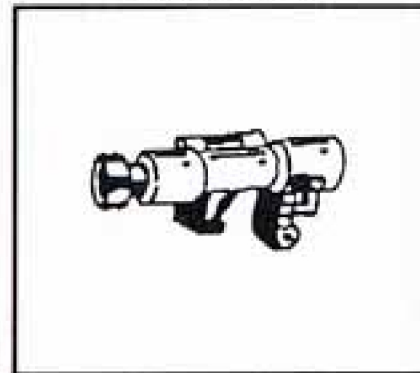

### Hyper Bazooka

Federal Army's new weapon. It can go through the cockpit of choppers

## EARNED WEAPONS



### Flare Bomb

Use in the cave,  
use with start button



### Player

Shoot in 8 directions,  
wave wires

## BONUS CHARACTERS



### Medicine

Recovers player's energy  
up to max.  
Use with start button

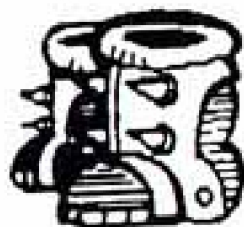

### Iron Boots

Kick and kill enemies



### Permit

Needed to enter certain  
neutral areas



### Magazine System

You can combine with  
Normal Gun and make  
it a Magazine Gun



### Helmet

Will protect you from  
enemies' bullets 3 times

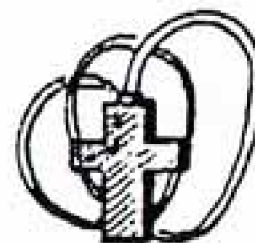

### Charm

Repulse one bullet



## BONUS CHARACTERS

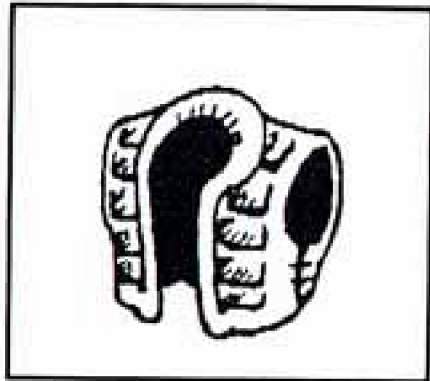

**Bulletproof Vest**  
Repulse one out of  
two bullets

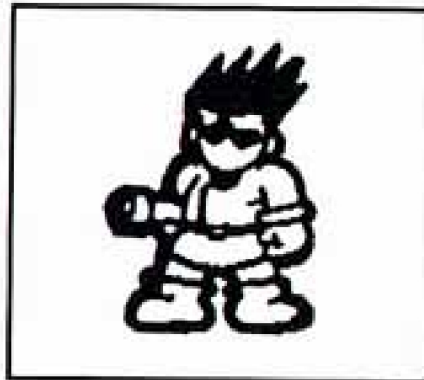

**1 Up**  
Add one player

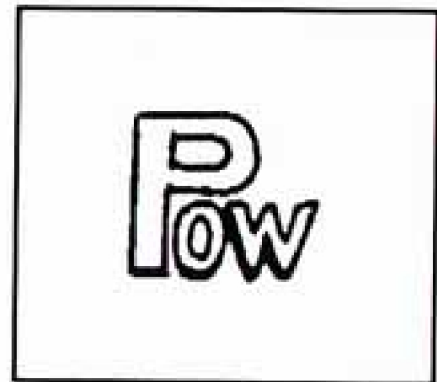

**POW**  
Energy ball will appear  
and go around the player  
to protect him for 7 sec.

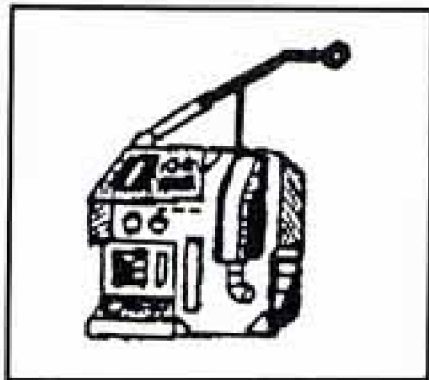

**Communicator**  
There are  $\alpha$ ,  $\beta$ ,  $\delta$ ,  $s$   
Communicators, You can  
communicate with  
compatible ones

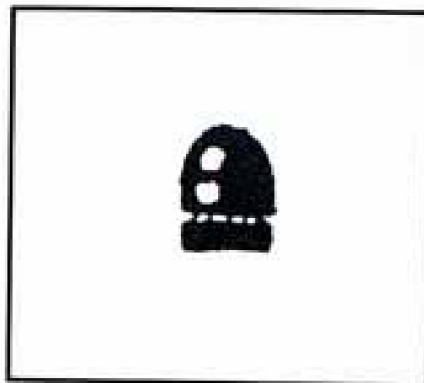

**Bullet**  
Appears when you defeat  
enemies

# ENEMY CHARACTERS

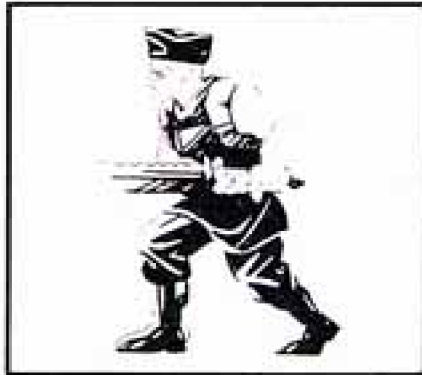

**Knife Wielding  
Soldier**



**Soldiers**  
Run towards the Player  
and shoot



**Suicide Bomber**  
Throw bombs at Player  
from a certain distance



**Jeep**  
Move sideways and shoots  
downwards



**Bearded Soldier**

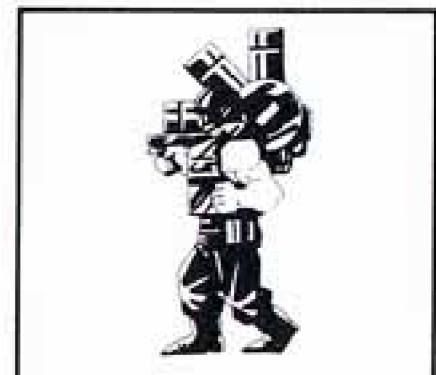

**Giant Soldier  
(Boss)**

# ENEMY CHARACTERS



**Barrier Soldier**

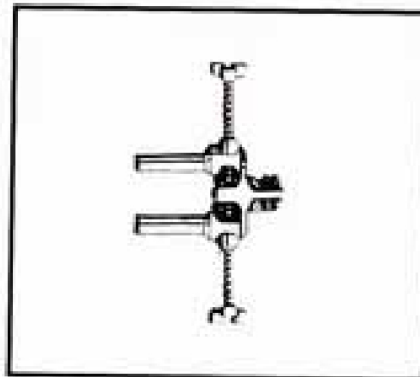

**Double Deck  
Cannon**

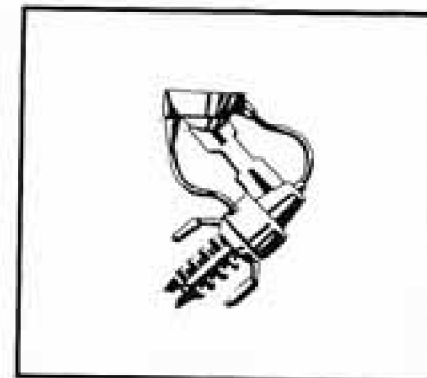

**Laser Cannon**



**Helicopter**

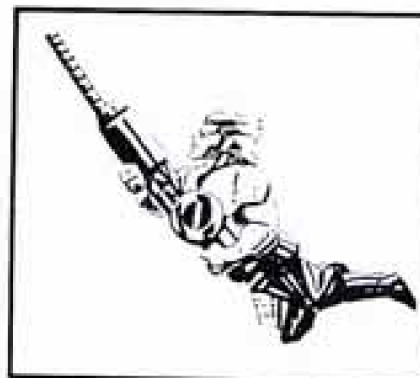

**Wired Gunner  
(Boss)**



**Construction  
Soldier**

# ENEMY CHARACTERS



**Generalissimo**



**Dwarf**



**Wired Soldier**

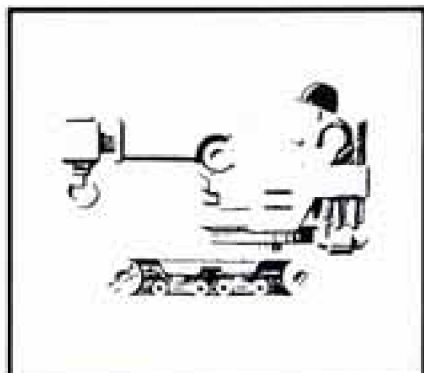

**Crane Caterpillar**



**Normal Soldier**

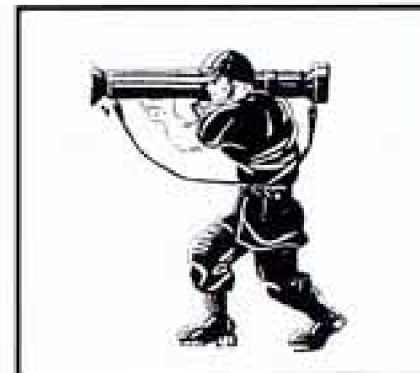

**Bazooka**

# ENEMY CHARACTERS

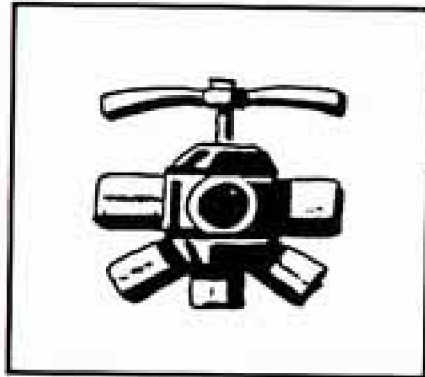

Pod

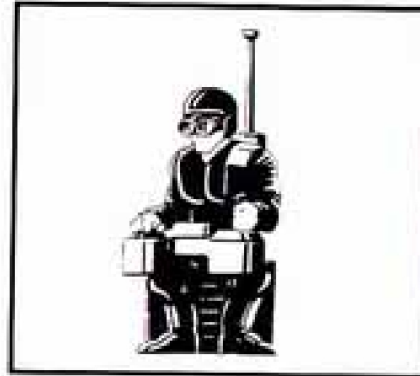

Remote Control  
Soldier

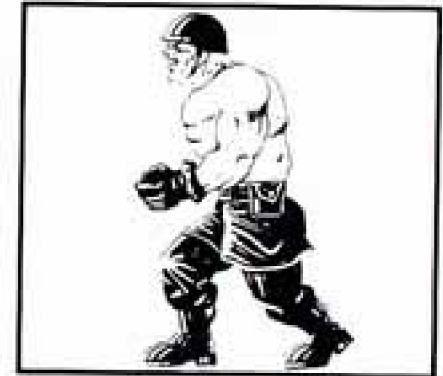

Heavy Object  
Throwing Soldier

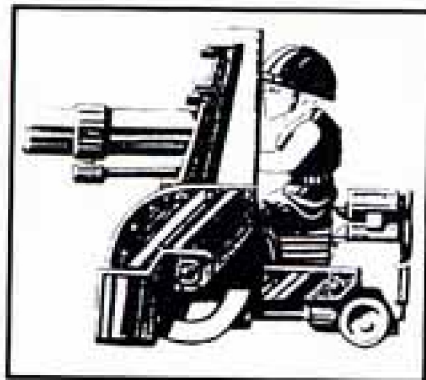

Cannon Mobile

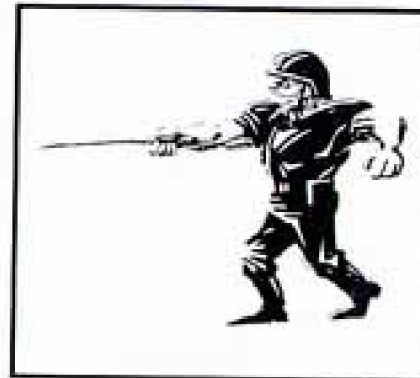

Commander

## **HINTS/SCORING/MEMO**

---

---

---

---

---

---

---

---

---

---

---

---

\*Instruction Manual by Paul Biederman

\*Game counsellors available 8 a.m. to 5 p.m. PST at (408) 745-7081

## COMPLIANCE WITH FCC REGULATIONS

This equipment generates and uses radio frequency energy and if not installed and used properly, that is, in strict accordance with the manufacturers' instructions, may cause interference to radio and television reception. It has been type tested and found to comply with the limits for a Class B computing device in accordance with the specifications in Subpart J of Part 15 of FCC Rules, which are designed to provide reasonable protection against such interference in a residential installation. However, there is no guarantee that interference will not occur in a particular installation. If this equipment does cause interference to radio or television reception, which can be determined by turning the equipment off and on, the user is encouraged to try to correct the interference by one or more of the following measures:

- Reorient the receiving antenna
- Relocate the computer with respect to the receiver
- Move the computer away from the receiver
- Plug the computer into a different outlet so that computer and receiver are on different circuits.

If necessary, the user should consult the dealer or an experienced radio/television technician for additional suggestions. The user may find the following booklet prepared by the Federal Communications Commission helpful:

How to Identify and Resolve Radio-TV Interference Problems.

This booklet is available from the U.S. Government Printing Office, Washington, D.C. 20402, Stock No. 004-000-00345-4.

# 90-DAY LIMITED WARRANTY

## 90-DAY LIMITED WARRANTY

**CAPCOM** U.S.A., Inc. ("Capcom") warrants to the original consumer that this Capcom Game Pak ("PAK") shall be free from defects in material and workmanship for a period of 90 days from date of purchase. If a defect covered by this warranty occurs during this 90-day warranty period, Capcom will repair or replace the PAK, at its option, free of charge.

To receive this warranty service:

1. DO NOT return your defective Game Pak to the retailer.
2. Notify the Capcom Consumer Service Department of the problem requiring warranty service by calling: Outside California State (800) 843-4632, or Inside California State call (408) 745-7081. Our consumer Service Department is in operation from 8:00 A.M. to 5:00 P.M. Pacific Time, Monday through Friday.
3. If the Capcom service technician is unable to solve the problem by phone, he will provide you with a Return Authorization number. Simply record this number on the outside packaging of your defective PAK, and return your PAK freight prepaid, at your risk of damage, together with your sales slip or similar proof-of-purchase within the 90-day warranty period to:

**CAPCOM** U.S.A., Inc.  
Consumer Service Department  
1283-C Mountain View/Alviso Road  
Sunnyvale, CA 94089

This warranty shall not apply if the PAK has been damaged by negligence, accident, unreasonable use, modification, tampering, or by other causes unrelated to defective materials or workmanship.

## REPAIRS AFTER EXPIRATION OF WARRANTY:

If the PAK develops a problem after the 90-day warranty period, you may contact the Capcom Consumer Service Department at the phone number noted above. If the Capcom service technician is unable to solve the problem by phone, he may provide you with a Return Authorization number. You may then record this number on the outside packaging of the defective PAK and return the defective PAK freight prepaid to Capcom, enclosing a check or money order for \$10.00 payable to CAPCOM U.S.A., Inc. Capcom will, at its option, subject to the conditions above, repair the PAK or replace it with a new or repaired PAK. If replacement PAKS are not available, the defective PAK will be returned and the \$10.00 payment refunded.

## WARRANTY LIMITATIONS:

ANY APPLICABLE IMPLIED WARRANTIES, INCLUDING WARRANTIES OF MERCHANTABILITY AND FITNESS FOR A PARTICULAR PURPOSE, ARE HEREBY LIMITED TO NINETY DAYS FROM THE DATE OF PURCHASE AND ARE SUBJECT TO THE CONDITIONS SET FORTH HEREIN. IN NO EVENT SHALL CAPCOM BE LIABLE FOR CONSEQUENTIAL OR INCIDENTAL DAMAGES RESULTING FROM THE BREACH OF ANY EXPRESS OR IMPLIED WARRANTIES.

The provisions of this warranty are valid in the United States only. Some states do not allow limitations on how long an implied warranty lasts or exclusions of consequential or incidental damages, so the above limitations and exclusion may not apply to you. This warranty gives you specific legal rights, and you may have other rights which vary from state to state.



# Look For These Popular Arcade-Proven Capcom Game Paks

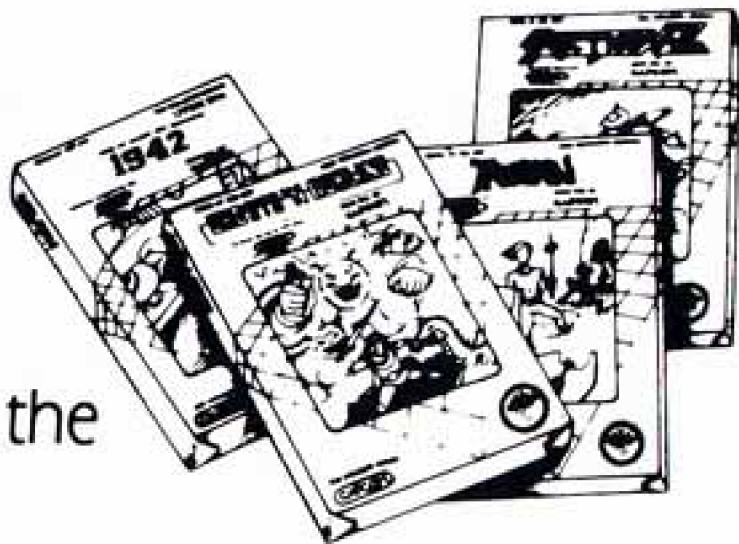

Licensed for play on the

**Nintendo**  
ENTERTAINMENT  
SYSTEM®

**PREMIER  
WORLD-WIDE  
ARCADE GAME  
DESIGNER**

**CAPCOM™**

1283-C Old Mountain View/Alviso Road  
Sunnyvale, CA 94089  
408-745-7081



**CAPCOM USA, INC.**  
1283-C MOUNTAIN VIEW/ALVISO ROAD  
SUNNYVALE, CALIFORNIA 94089

© 1988 CAPCOM USA, INC.  
PRINTED IN JAPAN

<http://www.nesfiles.com/>